



“my  
Reference,”

CREATION 70

CLIC

# THE BEST CLIC EVER ! LE CLIC LE PLUS RESISTANT !



**MADE IN  
EUROPE**



**PATENTED  
BREVETE**

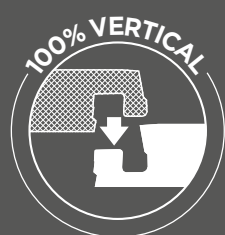

“ With Clic Revolution, we lay out the planks, edge over edge, and we install it. It's so simple, even when it comes to fit angles ! ”

Steve - **Installer**

“ Avec Clic Revolution, nous installons les lames bord à bord, et nous clipsons. C'est simple même pour la finition des angles ! ”

Steve - **Poseur**

**5X** MORE RESISTANT  
*PLUS RESISTANT*

**100%** VERTICAL CLIC

**30%** FASTER  
*PLUS RAPIDE*

# CREATION 70

## CLIC

214 x 1239 mm

242 x 1461 mm

391 x 729 mm

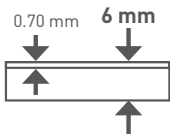

### PUR+ MATT



Easy maintenance /  
Facilité d'entretien

### 4D DESIGN

MATT SURFACE /  
SURFACE MATE



Natural look /  
Aspect naturel

CRISTAL WEAR LAYER /  
COUCHE D'USURE  
CRISTAL



High definition design  
& color /  
Décors haute définition

STRUCTURED  
EMBOSS & BEVEL /  
GRAINAGE STRUCTURÉ ET  
4 BORDS CHANFREINÉS

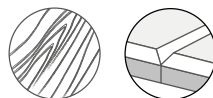

Ultra realistic surface /  
Décor ultra réaliste

2M PATTERN DESIGN /  
FILM DÉCOR 2M

Wide variety of  
planks or tiles /  
Large variété  
de lames & dalles

### DUO CORE TECHNOLOGY

1 RESILIENT COMFORT  
CORE /  
COUCHE SUPÉRIEURE  
CONFORT



Noise absorption /  
Sonorité à la marche  
améliorée (-10dB/stratifié)



Soft underfoot /  
Confort à la marche

2 RIGID CORE WITH  
FIBER GLASS VEIL /  
COUCHE RIGIDE +  
ARMATURE

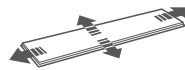

The best stability /  
Meilleure stabilité  
dimensionnelle



No adhesive /  
Pose sans colle



Renovation ceramic  
4 mm joint /  
Pose sur carrelage si joint  
< 4mm

### CLIC REVOLUTION 100% VERTICAL



30% Faster /  
Plus rapide

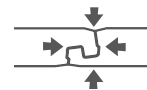

Durable clic system /  
Résistance du Clic



Heavy load resistance /  
Résistance au fort trafic



Waterproof joints /  
Pas d'infiltration  
dans les joints



Easy to change a plank /  
Changement  
de lame facile



GRACE BAY CREAM

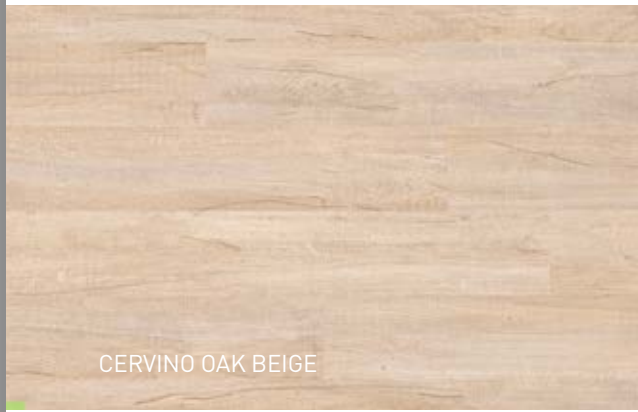

CERVINO OAK BEIGE



MUSE SAND

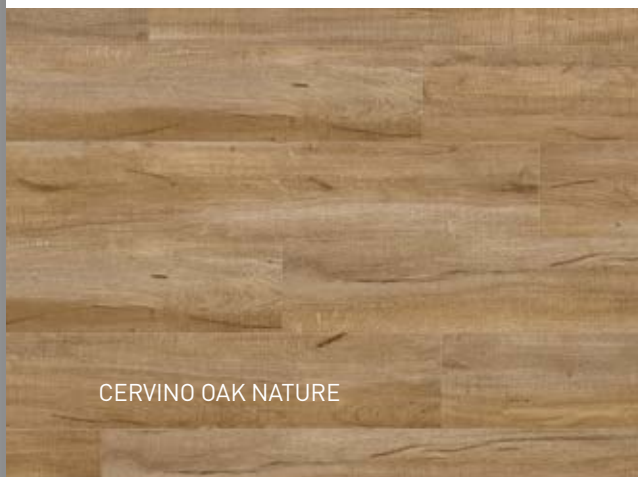

CERVINO OAK NATURE



MIDWEST



GRACE BAY CREAM 1049



214 x 1239



CERVINO OAK BEIGE 0797

242 x 1461



MIDWEST 0538

214 x 1239



MUSE SAND 1052

214 x 1239



CERVINO OAK NATURE 0798

242 x 1461





ONKA NATURAL 1055

 242 x 1461



ONKA HONEY 1054

 242 x 1461



MOON ISLAND 0358

 214 x 1239



PORTOBELLO 0357



 214 x 1239



ALBION 0577

 214 x 1239





ONKA HONEY



ALBION

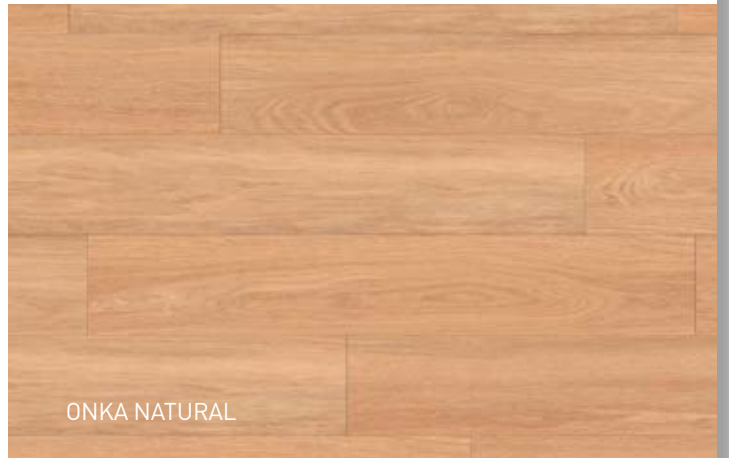

ONKA NATURAL



PORTOBELLO



MOON ISLAND

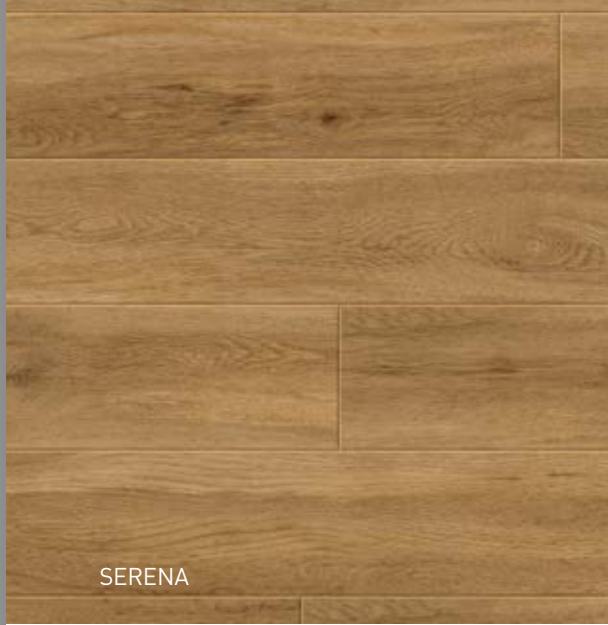

SERENA



WILD OAK



TOASTED WOOD ROADSTER



ONKA COFFEE



TOASTED WOOD CAFE





SERENA 0545

214 x 1239



WILD OAK 0359



214 x 1239



TOASTED WOOD ROADSTER 0800



242 x 1461



TOASTED WOOD CAFE 0799



242 x 1461



ONKA COFFEE 1057



242 x 1461





GRACE BAY BLACK 1050

214 x 1239



ONKA PEARL 1056

242 x 1461



MUSE SMOKED 1051



214 x 1239



TOASTED WOOD ASH 1053



242 x 1461



DEEP FOREST 0360



214 x 1239





ONKA PEARL



MUSE SMOKED



GRACE BAY BLACK



TOASTED WOOD ASH



DEEP FOREST



GENTLEMAN GREY



PURE CONCRETE DARK



DOCK GREY



PURE CONCRETE MEDIUM



PURE CONCRETE LIGHT



TERRAZZO NATURE



PURE CONCRETE BEIGE

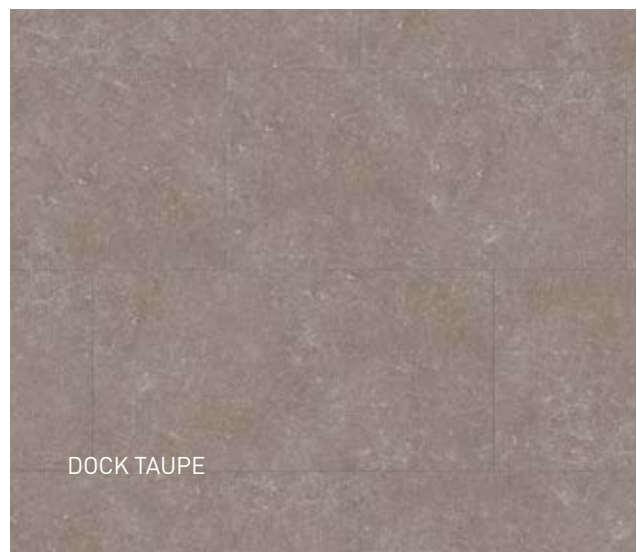

DOCK TAUPE



PURE CONCRETE BEIGE 1063

391 x 729



TERRAZZO NATURE 1067

391 x 729



DOCK TAUPE 0087

391 x 729



PURE CONCRETE LIGHT 1060

391 x 729



GENTLEMAN GREY 1058

391 x 729

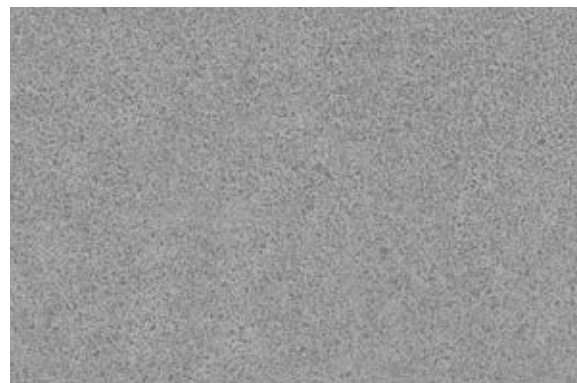

PURE CONCRETE MEDIUM 1061

391 x 729

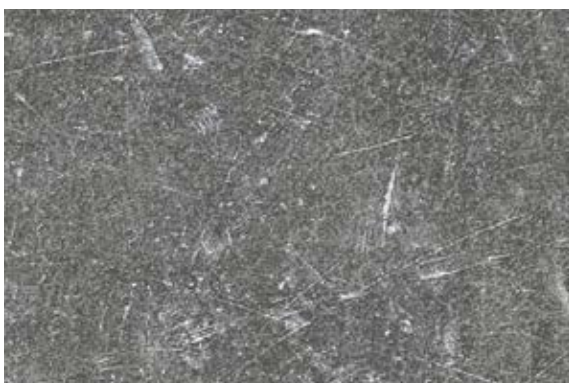

DOCK GREY 0085

391 x 729



PURE CONCRETE DARK 1062

391 x 729





ETNA DARK 1069

391 x 729



PRADO GREEN 1064

391 x 729



OXYD IRON 0089

391 x 729



OXYD PURE 0088

391 x 729



ETNA BEIGE 1068

391 x 729



TERRAZZO OCRE 1066

391 x 729



SECRET GARDEN WHITE 1059

391 x 729



PRADO TERRACOTTA 1065

391 x 729





PRADO TERRACOTTA



PRADO GREEN



SECRET GARDEN WHITE



TERRAZZO OCRE



ETNA BEIGE



ETNA DARK



OXYD IRON



OXYD PURE

# A SUSTAINABLE CHOICE UN CHOIX ÉCO-RESPONSABLE

100% Reach  
Phthalate free (excepte recycled content) /  
Sans phtalate (sauf matériaux recyclés)



55%  
Recycled content/  
Contenu recyclé

CREATION 70  
CLIC



10 times fewer  
CO<sub>2</sub> emissions  
than standard  
LVT process /  
Emissions de  
CO<sub>2</sub>/m<sup>2</sup> 10 fois  
plus faibles  
qu'un process  
classique



Adhesive free /  
Pose sans colle



Indoor air quality  
TVOC < 10 µg /  
Qualité de l'air intérieur  
TCOV < 10 µg



Easy to  
maintain,  
water base /  
Entretien  
facile



100%  
recyclable





CREATION 70 CLIC  
A FULL SET OF FINISHES / SOLUTIONS DE FINITION

I STAIRNOSING SOLUTION / SOLUTION NEZ DE MARCHE

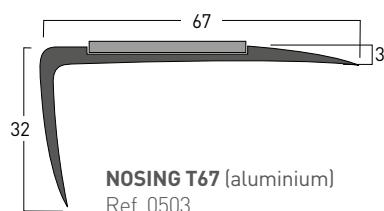
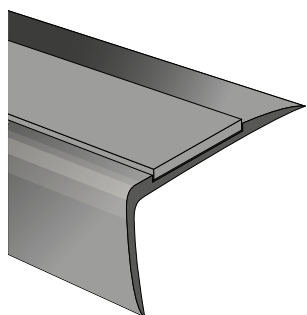

**NOSING T67** (aluminium)  
Ref. 0503

- Aluminum stair nosing for an elegant finish to steps while increasing safety with its non-slip strip. / *Nez de marche en aluminium qui donnera un fini élégant aux marches tout en assurant une sécurité d'usage grâce à sa bande antidérapante.*

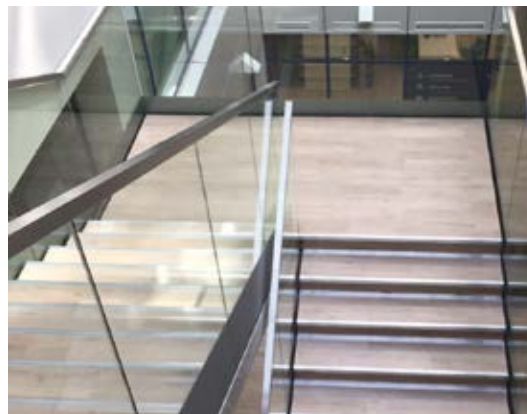

I PROFILES / PROFILÉS

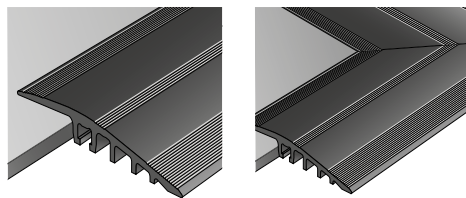

0505

1513

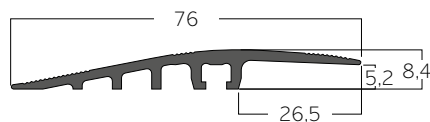

**RAMP 5-6MM** (aluminium)  
Ref. 0505

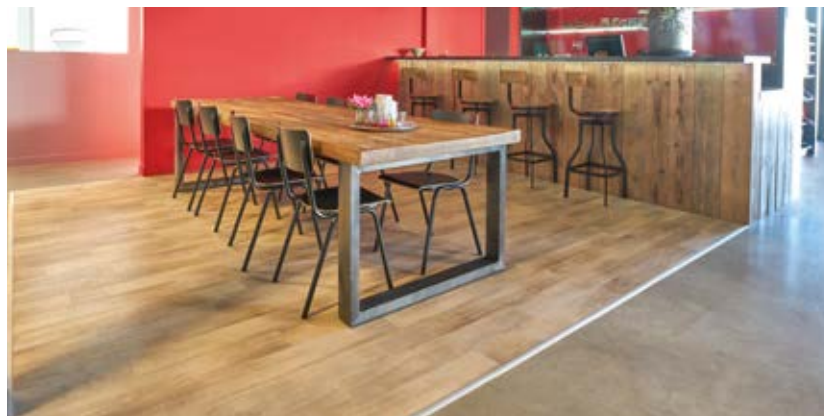

I ENTRANCE MATS - 3 TRAFFIC LEVELS / TAPIS D'ENTRÉE - 3 NIVEAUX DE TRAFIC



**QUICK MAT\***  
Ref. 8550



**LOOSE LAY ROMAT GT INSERT KIT**  
Ref. 1719



**KIT ESPLANADE 9000**  
Ref. 1700

**I ROMUS TOOLS / OUTILS ROMUS**



**FITTER KNIFE / COUTEAU ORCKAL\***  
Ref. 91108



**ANTI-BOUNCE Mallet / MAILLET ANTI-REBOND\***  
Ref. 94964



**LVT ROLLER / MAROUFLEUR SPÉCIAL LVT\***  
Gerflor ref. 058V / Romus ref. 93159

**I UNDERLAYERS / SOUS-COUCHE**



**GERFLOR ACOUSTIC / 15 dB**  
Ref. 1798  
Format: 1m x 15 ml



**I ADHESIVE / COLLE**



**FIX & FREE 740**  
Ref. 058W  
Format: 1 x 25 ml = 18,5 m<sup>2</sup>

**I FLOOR PROTECTION / PROTECTION DE SOL**























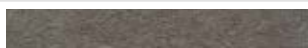



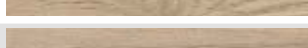







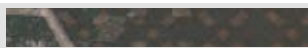

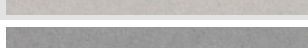

Ref. 058X

FOR MORE DETAILS  
visit [gerflor.com](http://gerflor.com)  
PLUS D'INFORMATIONS  
sur le site [gerflor.fr](http://gerflor.fr)

**Gerflor**  
theflooringgroup

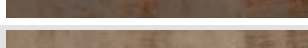
LVT finishes brochure  
Solutions de finition LVT

CREATION 70  
CROSS REFERENCES / EN UN CLIN D'OEIL

| SCANS / COLORIS   | COLOR DESIGN / DÉCORS        | EMBOSS / GRAIN | CLIC / À CLIPSER   | LOOSELAY / PLOMBANT   | GLUE DOWN / À COLLER  | DESIGN SKIRTING   |
|---|------------------------------|----------------|--|---|---|---|
|   |                              |                |  |  |  |  |
|    | ALBION - 0577                | NATURAL        | 214x1239 mm  |   | 184x1371 mm   | S108  |
|    | CERVINO OAK BEIGE - 0797     | NATURAL        | 242x1461 mm  |   | 230x1500 mm   | S011  |
|    | CERVINO OAK NATURE - 0798    | NATURAL        | 242x1461 mm  |   | 230x1500 mm   | S109  |
|    | DEEP FOREST - 0360           | BRUSHED        | 214x1239 mm  |   | 152x914 mm  | S110  |
|    | DOCK GREY - 0085             | HAMMERED       | 391x729 mm   | 914x914 mm  | 457x914 mm  | S111  |
|    | DOCK TAUPE - 0087            | HAMMERED       | 391x729 mm   | 914x914 mm  | 457x914 mm  | S020  |
|    | ETNA BEIGE - 1068            | HAMMERED       | 391x729 mm   |   |   | WHITE / BLANC   |
|    | ETNA DARK - 1069             | HAMMERED       | 391x729 mm   |   |   | WHITE / BLANC   |
|    | GENTLEMAN GREY - 1058        | TEXTILE        | 391x729 mm   | 600x600 mm  |   | WHITE / BLANC   |
|    | GRACE BAY BLACK - 1050       | NATURAL        | 214x1239 mm  |   |   | WHITE / BLANC   |
|   | GRACE BAY CREAM - 1049       | NATURAL        | 214x1239 mm  |   |   | WHITE / BLANC   |
|  | MIDWEST - 0538               | NATURAL        | 214x1239 mm  | 229x1220 mm   | 152x914 mm  | S039  |
|  | MOON ISLAND - 0358           | BRUSHED        | 214x1239 mm  | 229x1220 mm   | 152x914 mm  | S034  |
|  | MUSE SAND - 1052             | NATURAL        | 214x1239 mm  |   |   | S117  |
|  | MUSE SMOKED - 1051           | NATURAL        | 214x1239 mm  |   |   | S118  |
|  | ONKA COFFEE - 1057           | NATURAL        | 242x1461 mm  |   |   | WHITE / BLANC   |
|  | ONKA HONEY - 1054            | NATURAL        | 242x1461 mm  | 229x1220 mm   |   | S121  |
|  | ONKA NATURAL - 1055          | NATURAL        | 242x1461 mm  |   |   | S122  |
|  | ONKA PEARL - 1056            | NATURAL        | 242x1461 mm  |   |   | S120  |
|  | OXYD IRON - 0089             | PERFORATED     | 391x729 mm   |   | 457x914 mm  | WHITE / BLANC   |
|  | OXYD PURE - 0088             | PERFORATED     | 391x729 mm   |   | 457x914 mm  | WHITE / BLANC   |
|  | PORTOBELLO - 0357            | BRUSHED        | 214x1239 mm  | 229x1220 mm   | 152x914 mm  | S053  |
|  | PRADO GREEN - 1064           | STONE          | 391x729 mm   |   |   | WHITE / BLANC   |
|  | PRADO TERRACOTTA - 1065      | STONE          | 391x729 mm   |   |   | WHITE / BLANC   |
|  | PURE CONCRETE BEIGE - 1063   | HAMMERED       | 391x729 mm   |   |   | WHITE / BLANC   |
|  | PURE CONCRETE DARK - 1062    | HAMMERED       | 391x729 mm   | 914x914 mm  |   | WHITE / BLANC   |
|  | PURE CONCRETE LIGHT - 1060   | HAMMERED       | 391x729 mm   | 914x914 mm  |   | WHITE / BLANC   |
|  | PURE CONCRETE MEDIUM - 1061  | HAMMERED       | 391x729 mm   | 914x914 mm  |   | WHITE / BLANC   |
|  | SECRET GARDEN WHITE - 1059   | STONE          | 391x729 mm   |   |   | WHITE / BLANC   |
|  | SERENA - 0545                | NATURAL        | 214x1239 mm  |   | 152x914 mm  | S132  |
|  | TERRAZZO NATURE - 1067       | STONE          | 391x729 mm   |   |   | WHITE / BLANC   |
|  | TERRAZZO OCRE - 1066         | STONE          | 391x729 mm   |   |   | WHITE / BLANC   |
|  | TOASTED WOOD ASH - 1053      | NATURAL        | 242x1461 mm  |   |   | WHITE / BLANC   |
|  | TOASTED WOOD CAFE - 0799     | NATURAL        | 242x1461 mm  |   | 230x1500 mm   | WHITE / BLANC   |
|  | TOASTED WOOD ROADSTER - 0800 | NATURAL        | 242x1461 mm  |   | 230x1500 mm   | WHITE / BLANC   |
|  | WILD OAK - 0359              | BRUSHED        | 214x1239 mm  |   | 152x914 mm  | S075  |

WHITE / BLANC = S001

**CREATION 70 CLIC**  
**DESIGN SKIRTINGS / PLINTHES DÉCOR**

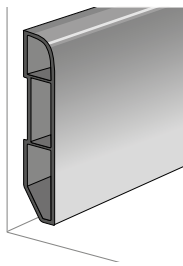
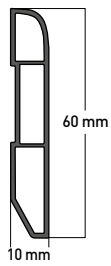

**VINYL DESIGN SKIRTING / DESIGN SKIRTING PVC**

Ref. 6086 + color code / code couleur

- Water resistant  
*Résistant à l'eau*
- Can be adhesived  
*Peut être adhésivé*
- Some colors available  
(see cross references table)  
*Disponible sur une sélection de coloris (voir tableau ci-contre)*

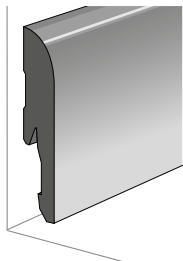
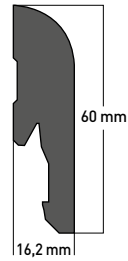

**MDF DESIGN SKIRTING**

Ref. 5947 + color code / code couleur

- Can be clipped  
*Peut être clipsé (ref. 5948)*
- Nailed or adhesived  
*Cloué ou adhésivé*
- Some colors available  
(see cross references table)  
*Disponible sur une sélection de coloris (voir tableau ci-contre)*



Also available in white  
can be painted over /  
*Egalement disponible dans  
une version blanche à peindre*

**EXCLUSIVE EMBOSSES FOR ENHANCED DESIGNS**  
**SURFACES GRAINÉES POUR UNE MATIÈRE TRÈS RÉALISTE**

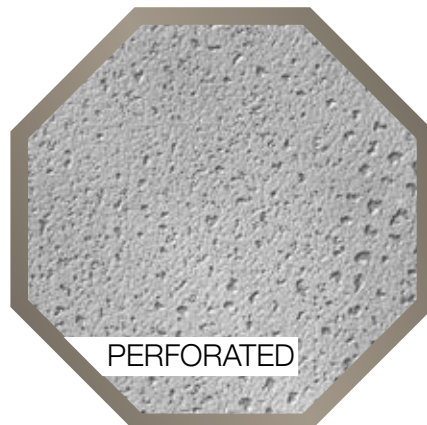
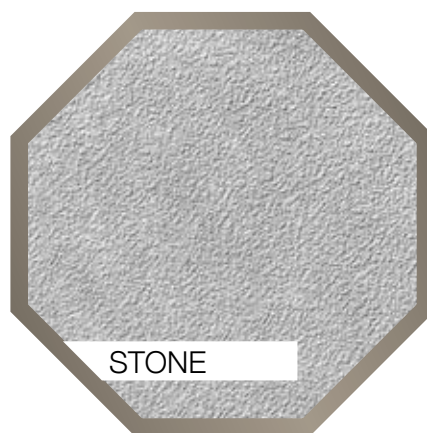

# CREATION 70 CLIC

gerflor.com



\* information sur le niveau d'émission de substances volatiles dans l'air intérieur, présentant un risque de toxicité par inhalation, sur une échelle de classe allant de A+ (très faibles émissions) à C (fortes émissions).

CREATION 70  
CLIC

## DESCRIPTION / BESCHREIBUNG / BESCHRIJVING / DESCRIPTION / DESCRIPCIÓN / DESCRIZIONE

|  |              |                  |              |              |               |
|--|--------------|------------------|--------------|--------------|---------------|
| Total Thickness / Gesamtdicke / Totale dikte / Épaisseur totale / Espesor total / Espessura total / Spessore totale  | EN ISO 24346 | mm               | 6.00         |              |               |
|  | ASTM F386-02 | inch             | 0.24         |              |               |
| Thickness of the wearlayer / Dicke der Nuttschicht / Dikte van de slijtlaag / Épaisseur couche d'usure / Espesor capa de uso / Espessura camada de desgaste / Spessore strato di usura | EN ISO 24340 | mm               | 0.70         |              |               |
|  | ASTM F410-02 | inch             | 0.03         |              |               |
| Weight / Flächengewicht / Gewicht / Poids / Peso / Peso / Peso   | EN ISO 23997 | g/m <sup>2</sup> | 9850         |              |               |
| Size / Format / Afmetingen / Format / Dimensiones / Dimensões / Dimensioe  | ISO 24342    | mm               | 214x1239     | 242x1461     | 391x729       |
|  | ASTM F 536   | inch             | 8.4" x 48.7" | 9.5" x 57.5" | 15.3" x 28.7" |
| Number of planks / tiles and sqm per box   | -            | -                | -            | -            | -             |

## CLASSIFICATION / KLASSIFIKATION / CLASSIFICATIE / CLASSIFICATION / CLASIFICACIONES / CLASSIFICAÇÕES / CLASSIFICAZIONI

|  |                     |       |  |  |  |
|--|---------------------|-------|--|--|--|
| Norm/Product Specification / Produktnorm / Technische eigenschappen / Norme/Spécification produit / Normas / Normas / Norma prodotto   | -                   | -     | EN ISO 10582                                 |  |  |
|  | ASTM F 1700-04      | -     | Class III Type B                             |  |  |
| European Classification / Europäische Klassifizierung / Europese classificatie / Classement européen / Clasificación europea / Classificação Europeia / Europea                      | EN ISO 10874        | Class | 34 - 43                                      |  |  |
| Classement UPEC  | -                   | -     | Pour pose dans les locaux classés U4P3E1/2C2 |  |  |
| Fire Rating / Brandverhalten / Brand classificatie / Classement Feu / Fuego / Fogo / Reazione al fuoco   | EN 13 501-1         | Class | Bfl-s1                                       |  |  |
| Static Electrical Propensity / Begehauladung / Elektrische eigenschappen / Potentiel de charge / Comportamiento electrostático / Comportamento electrostático / Resistenza elettrica | EN 1815             | kV    | < 2  |  |  |
| Slip Resistance Wet / Rutschhemmung / Anti-slip / Glissance humide / Deslizamiento húmedo / Escorregamento húmido / Scivolosità umida <sup>(1)</sup>                                 | DIN 51130 / BGR 181 | Class | R10  |  |  |

## PERFORMANCES / TECHNISCHE EIGENSCHAFEN / TESTRESULTAAT / PERFORMANCE / CUALIDADES TÉCNICAS / PERFORMANCES / CARATTERISTICHE TECNICHE

|   |                 |                 |           |  |  |
|---|-----------------|-----------------|-----------|--|--|
| Wear Resistance / Verschleißverhalten / Slijtvastheid / Résistance à l'usure / Abrasión / Abrasão / Resistenza all'abrasione  | EN 660.2        | mm <sup>3</sup> | ≤ 2.0     |  |  |
| Wear Group / Verschleißgruppe / Groep slijtvasheid / Groupe d'abrasion / Grupo de abrasión / Grupo de abrasão / Gruppo di abrasione   | QB 30           | group           | T         |  |  |
| Type Binder content / Bindemittelgehalt / Teneur en agent liant / Contenido en ligante / Conteúdo em ligante  | ISO 10582       | group           | I         |  |  |
| Dimensional stability (norm) / Maßstabilität (norm) / Maatvastheid (norm) / Stabilité dimensionnelle (norme) / Estabilidad Dimensional (Exigencial) / Estabilidade dimensional (normalização) / Stabilità dimensionale (requisito normativo)  | EN ISO 23999    | %               | ≤ 0.15    |  |  |
| Dimensional stability (average measured value) / Maßstabilität (Durchschnittswert) / Stabilité dimensionnelle (valeur moyenne mesurée) / Maatvastheid (gemeten gemiddelde waarde) / Estabilidad Dimensional (Valor medido) / Estabilidade Dimensional (Valor medio) / Stabilità dimensionale (rilevata) | -               | %               | ≤ 0.05    |  |  |
| Residual Indentation / Resteindruck / Indrukbelasting / Poinçonnement statique rémanent / Punzonamiento / Punçoamento / Impronta  | EN ISO 24343-1  | mm              | ≤ 0.10    |  |  |
| Impact sound insulation / Trittschallverbesserungsmaß / Geluidsisolatie / Isolation acoustique bruits de chocs / Acústica / Isolamento acústico   | EN ISO 717-2    | dB              | 4         |  |  |
| Room Impact / Raumschall / Loopgeluid / Sonorité à la marche / Rumore al calpestio / Sonoridad en la pisada / Sonoridade ao andar   | NF S 31074      | dB              | 78        |  |  |
| Castor chair test / Stuhlrollenbeanspruchung / Rolweerstand bureaustoelen / Essai de la chaise à roulettes / Determinación del efecto de una silla con ruedas / Resistência a cadeiras de rodas / Resistenza al passaggio di sed (Type W)   | ISO 4918        | -               | OK        |  |  |
| Thermal Conductivity / Wärmeleitfähigkeit / Thermische weerstand / Conductivité thermique / Conductividad térmica / Condutividade térmica / Resistenza termica / Värmeledningsmotstånd / Varmemotstånd  | EN ISO 10456    | W/(m.K)         | 0.25      |  |  |
| Colour Fastness / Lichtechtheid / Lichtechtheid / Solidité lumière / Resistencia a la luz / Estabilidade das cores / Solidità alla luce   | EN 20 105 - B02 | degree          | ≥ 6       |  |  |
| Surface Treatment / Oberflächenvergütung / Oppervlaktebehandling / Traitement de surface / Tratamiento de superficie / Tratamento de superficie / Trattamento di superficie   | -               | -               | PUR+ Matt |  |  |
| Chemical Products Resistance / Verhalten gegenüber Chemikalien / Chemische bestendigheid / Résistance aux produits chimiques / Resistencia a los productos químicos / Resistência aos produtos químicos / Resistenza ai prodotti chimici <sup>(2)</sup>   | EN ISO 26987    | -               | OK        |  |  |

## ENVIRONMENT/INDOOR AIR QUALITY / UMWELT/RAUMLUFTQUALITÄT / ENVIRONNEMENT/QUALITÉ DE L'AIR INTÉRIEUR / MEDIO AMBIENTE/CALIDAD INTERIOR DEL AIRE INTERIOR / MEIO AMBIENTE/QUALIDADE DO AR INTERIOR

|  |             |                   |             |  |  |
|--|-------------|-------------------|-------------|--|--|
| TVOC after 28 days / TVOC (28 Tage) / TVOC (28 dagen) / TVOC après 28 jours / TVOC (28 dias) / TVOC (28 dias) / TVOC (28 giorni) / TVOC (28 dagar) / TVOC (28 dager) | ISO 16000-6 | µg/m <sup>3</sup> | < 10        |  |  |
| Certification / Zeugnis / Certification / Certificado / Certificação   | -           | -                 | Floorscore® |  |  |

## CE MARKING / CE KENNZEICHNUNG / EG\_CONFORMITEITSMERK / MARQUAGE CE / MARCA DE CONFORMIDAD CE / MARCA DE CONFORMIDADE CE / MARCATURA CE DI CONFORMITA

|    |          |   |  |  |  |  |
|----|----------|---|--|--|--|--|
| CE | EN 14041 | - |  |  |  |  |
|----|----------|---|--|--|--|--|

(1) Ramp test with oil / Schiefe Ebene / Plan incliné avec huile

(2) Beständig gegenüber nicht färbenden alkoholhaltigen Handdesinfektionsmitteln, Haushaltschemikalien und verdünnten Säuren und Laugen bei kurzzeitiger Einwirkung.

## CREATION 70 CLIC, A SUSTAINABLE CHOICE



**COMPOSITION**  
100% REACH  
Phthalate Free  
(except recycled content)



**INDOOR AIR QUALITY**  
TVOC below detection level  
No Formaldehyde emission



**RECYCLABILITY**  
Recycled content 55%  
100% Recyclable



**INSTALLATION**  
Clic: Adhesive free



**LCA**  
Lowest Carbon Footprint  
CO<sub>2</sub> emissions/sqm  
10 times lower than standard process



**WELLNESS**  
Walking noise reduction:  
-10dB vs laminate

**IMPORTANT:** The information contained in this document is valid from 01/06/2019 and is subject to change at any time without notice. In the context of constantly changing technology, our customers are responsible, prior to any use, for checking with us that this document is the version in force.

**Gerflor**  
theflooringgroup